

AD-758 136

Some Biological Effects of Microwave Irradiation in the Rat

Walter Reed Army Institute of Research

MARCH 1973

Distributed By:

NTIS

National Technical Information Service
U. S. DEPARTMENT OF COMMERCE

DISCLAIMER NOTICE

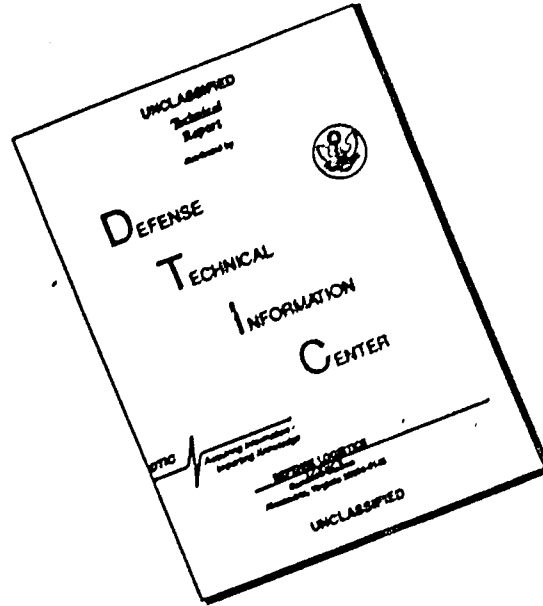

THIS DOCUMENT IS BEST QUALITY AVAILABLE. THE COPY FURNISHED TO DTIC CONTAINED A SIGNIFICANT NUMBER OF PAGES WHICH DO NOT REPRODUCE LEGIBLY.

**SOME BIOLOGICAL EFFECTS OF MICROWAVE
IRRADIATION IN THE RAT**

**T. Daryl Hawkins
H. Mark Grove
Thomas W. Heiple
John Schrot**

March 1973

**Department of Microwave Research
Walter Reed Army Institute of Research
Washington, D. C. 20012**

**U. S. Army Mobility Equipment Research
and Development Center
Fort Belvoir, Va. 22060
Inter Army Order 1247 and 2544**

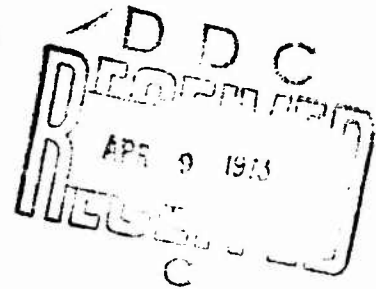

Approved for public release; distribution unlimited

Reproduced by
**NATIONAL TECHNICAL
INFORMATION SERVICE**
U S Department of Commerce
Springfield VA 22151

DOCUMENT CONTROL DATA - R & D		
<i>(Security classification of title, body of abstract and indexing information must be entered when the classification is classified)</i>		
1. ORIGINATING ACTIVITY (Corporate name) Department of Microwave Research Walter Reed Army Institute of Research Washington, D. C. 20012		2. REPORT SECURITY CLASSIFICATION Unclassified
3. REPORT TITLE Some Biological Effects of Microwave Irradiation in The Rat		4. GROUP NA
4. DESCRIPTIVE NOTES (Type of report and inclusive dates) July 1971 - January 1973		
5. AUTHOR(S) (Last name, initials, first name) T. Daryl Hawkins, H. Mark Grove, Thomas W. Heiple, John Schroi		
6. REPORT DATE March 1973	7a. TOTAL NO. OF PAGES 34	7b. NO. OF FIGS 5
8. CONTRACT OR GRANT NO. LAO 1247 and LAO 2544	9a. ORIGINATOR'S REPORT NUMBER(S) NA	
9. PROJECT NO. 1J662712AJ21	9b. OTHER REPORT NO(S) (i.e., other numbers that may be assigned this report)	
10. DISTRIBUTION STATEMENT Approved for public release; distribution unlimited.		
11. SUPPLEMENTARY NOTES	12. SPONSORING MILITARY ACTIVITY U.S. Army Mobility Equipment Research and Development Center Fort Belvoir, Va. 22060	
13. ABSTRACT <p>This report describes two major experimental efforts performed by the Microwave Research Department, Walter Reed Army Institute of Research, Walter Reed Army Medical Center. The first study examines the lethal effects of 3000 MHz exposures in rat. The second study, which was performed concurrently with the first, examined behavioral performance decrements in rat as a function of both wavelength and power density. The lethality study indicated that more total energy is required to produce lethal effects with low power densities than with higher ones. The behavioral experiment indicated a substantial frequency dependent effect of microwave irradiation. The results raise the possibility of similar frequency dependent effects in other species.</p>		

FORM 1041, 1 JAN 64, WHICH IS OBSOLETE FOR ARMY USE.

14. KEY WORDS	LINK A		LINK B		LINK C	
	ROLE	WT	ROLE	WT	ROLE	WT
Microwaves Radiofrequency waves Electromagnetic waves Operant Conditioning Behavior Performance Lethality						

I. LETHAL EFFECTS OF 3000 MHz IRRADIATION IN THE RAT

Introduction

A dearth of careful parametric investigations of the lethal effects of microwave irradiation exists in the world literature. A notable exception in this relative void is the work of Susskind (1961). With mice exposed at 9270 Mhz, he found that the average time to death was directly related to the power density, through a fairly wide range of power levels (68-380 mw/cm^2). The highest power level resulted in the shortest time to death. Progressively lower power levels yielded increasing times to death. A threshold for lethal effects appeared to be between 58 and 68 mw/cm^2 .

The present experiment is similar to Susskind's in that we examined the lethal effects of microwave irradiation in rats across a wide range of microwave parameters. The emphasis was in determining the relation between the duration of microwave exposure and the lethal energy density (LD50), defined as the estimated energy density at which 50 percent of the subjects survived for five minutes following exposure.

Method

One hundred and seventy-four male Wistar rats from the Walter Reed colony served as subjects. For several weeks prior to experimentation, each rat was raised in an individual cage at an ambient temperature of $76 \pm 2^\circ\text{F}$ and under continuous lighting. The rats were

weighed daily, five days per week, at approximately 0730 hours. When an individual rat had grown to within the selected body-weight range of 180 to 210 grams, it was scheduled for a single microwave exposure, between 0900 and 1200 hours.

Each rat was assigned to one of four durations of exposure (0.5, 1, 2, and 4 minutes), providing four major groups of animals. Each group was further divided into subgroups of 7 to 14 rats assigned to different energy density levels.

A chamber, anechoic for microwave signals and maintained at $70 \pm 1^\circ\text{F}$, was used for the exposures. Power at 3000 Mciz was transmitted by an ellipsoidal antenna six feet in diameter. The focal points of the reflector were at 32.848 and 74.848 inches from the vertex of the antenna. The antenna feed consisted of an oversized circular choke groove in a circular flange mounted flush to the end of the exciting waveguide. At the frequency employed, WR284 guide was used. The phase center of this choked feed was positioned at the 32.848 inch focus. Polarization was vertical. The relative phase and amplitude distributions at the second focus are shown in Figures 1 and 2 for the E and H planes, respectively. Since the phase was uniform, the characteristics of the microwave energy at the focal plane mimiced those experienced in a Fraunhofer or far-field situation. As one departs from the focus, there is a deviation from the plane-wave characterization, that is for $d < d_{\text{focus}}$ the wavefront is converging and for $d > d_{\text{focus}}$ it is diverging. The on-axis behavior is shown in Figure 3 as a function of $z = d - d_{\text{focus}}$, where d is the axial distance from the reflector vertex.

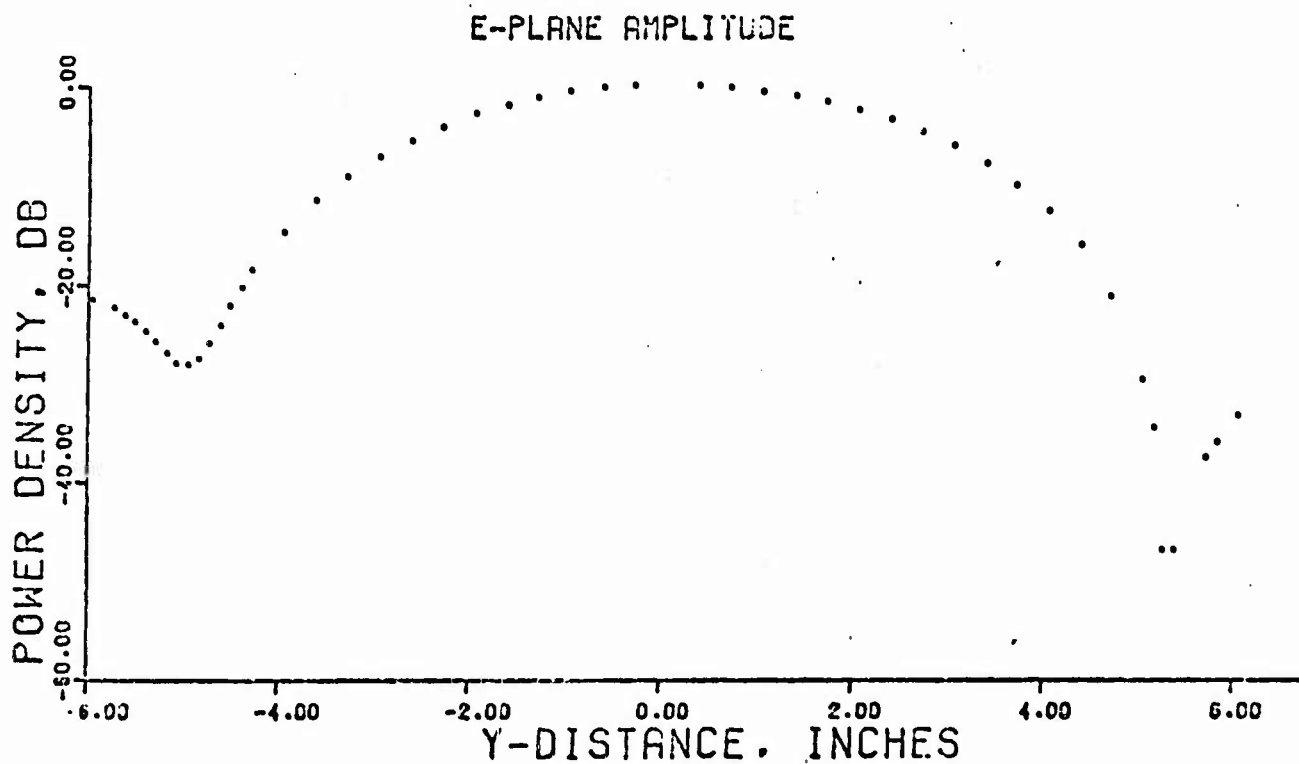
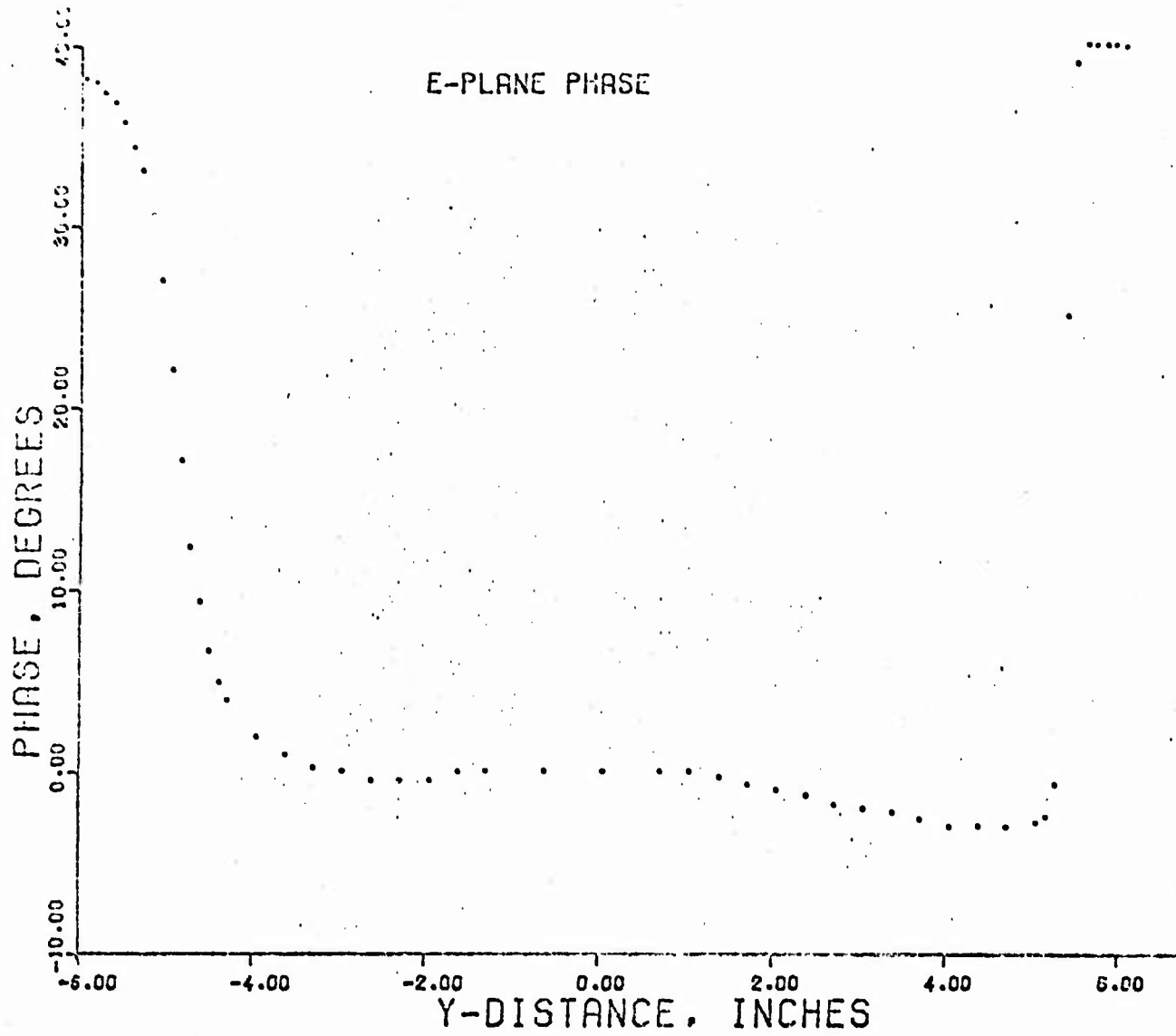

FIGURE 1 3

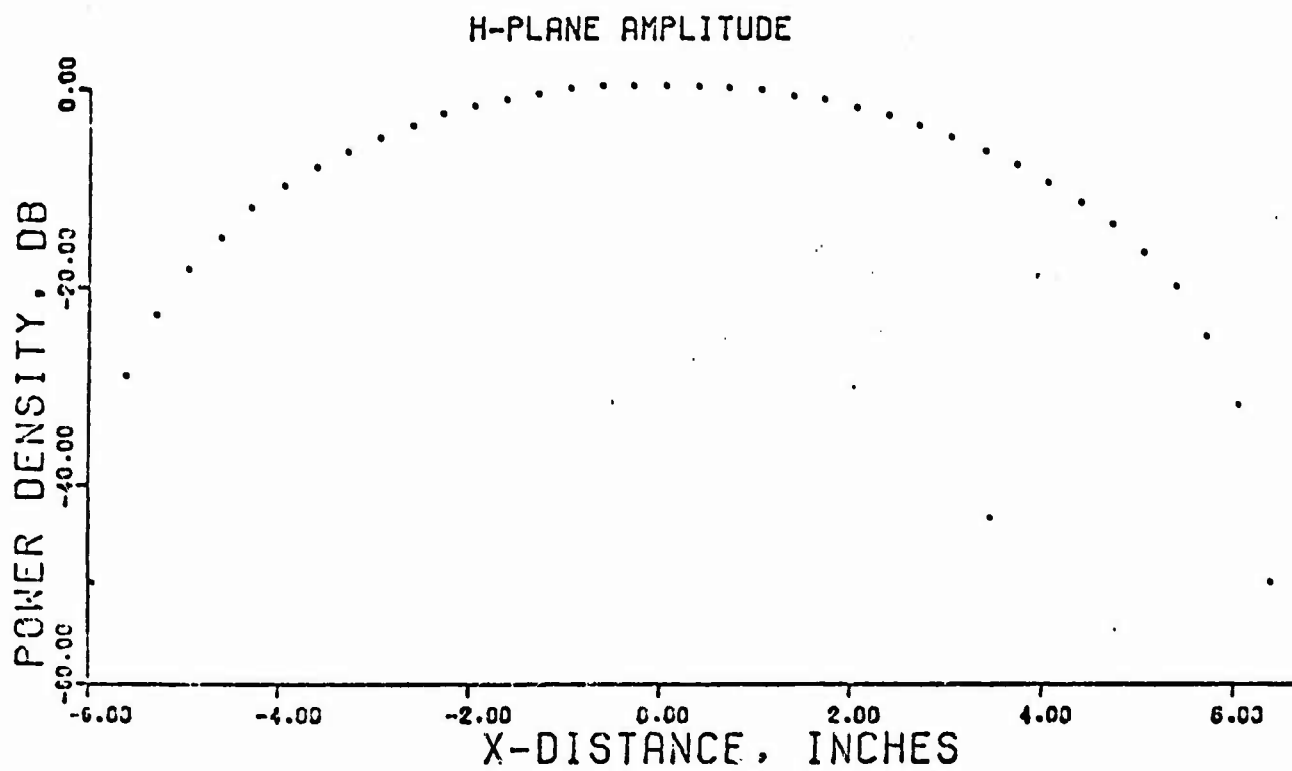
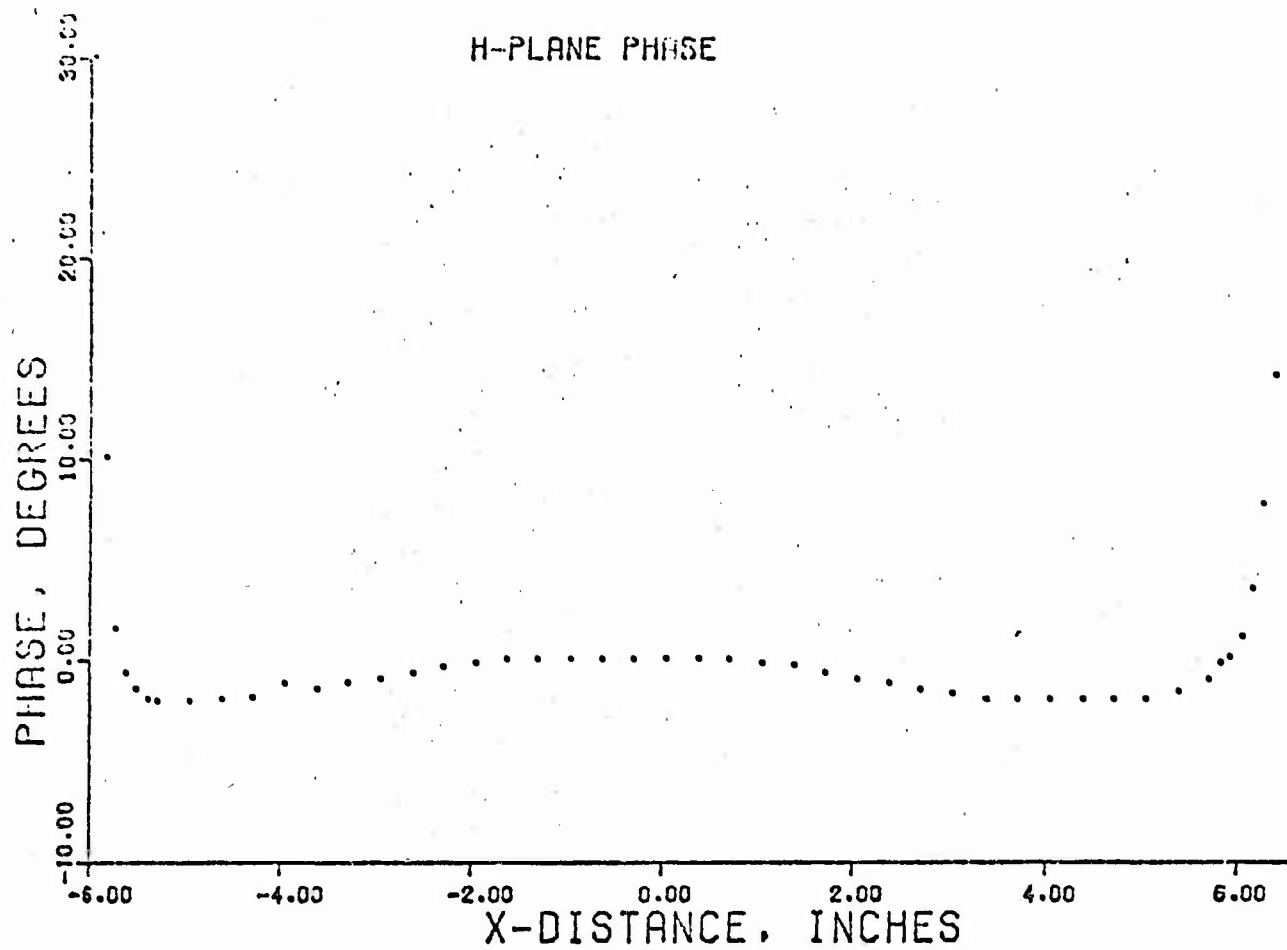

FIGURE 2

4

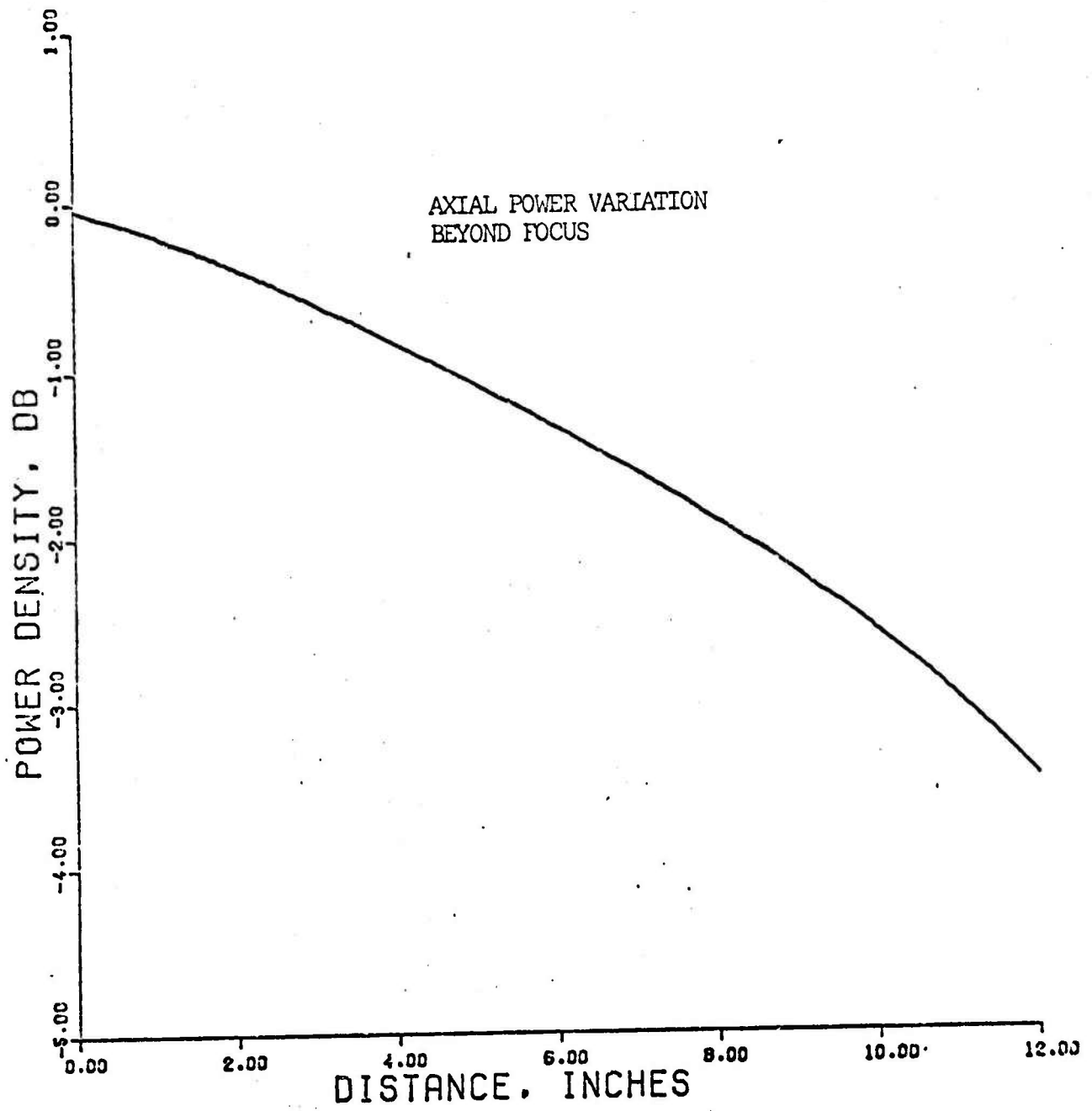

FIGURE 3

For the 3000 MHz case, the axial power density at the focus was 5.1 mw/cm^2 per watt into the antenna system. The source transmitter (*vide infra*) had a maximum CW generation capability of 2.0 kw so that a maximum power density of 10.2 watts/cm^2 could be achieved. The antenna was calibrated on the Scientific-Atlanta XYZ positioner and phase-amplitude recorder at the Georgia Institute of Technology. Point verifications were undertaken using a calibrated sleeve dipole on-site at the Walter Reed Army Institute of Research. The power density levels quoted are felt to be accurate within 1 db absolute, and consistent across the experiment to considerably better than that on a relative basis.

The transmitter consisted of a sweep-frequency generator (in this case operated in the CW mode) and 2 kw klystron amplifier. The klystron output was monitored by a calibrated directional coupler and a leveling loop was established to maintain a constant transmitted power. The coupler was calibrated on a Hewlett-Packard 8542A Automatic Network Analyzer to an accuracy of 0.67 db, mean, indirectly traceable to NBS. A block diagram of the transmitter is given in Figure 4.

The rats were exposed one at a time in one of several identical styrofoam boxes, which were designed to minimize head and body movements. The interior surfaces of these boxes formed a rectangular compartment ($1\text{-}5/8 \times 1\text{-}5/8 \times 6$ inches) when a square rear plug was in position. The inner edges of the front plug formed a hood which enclosed the rat's head. The top of the hood was canted 45° forcing the head into an inclined position. The sides of the hood were $1/4$ inch thick, restricting lateral movement. Holes with a diameter of

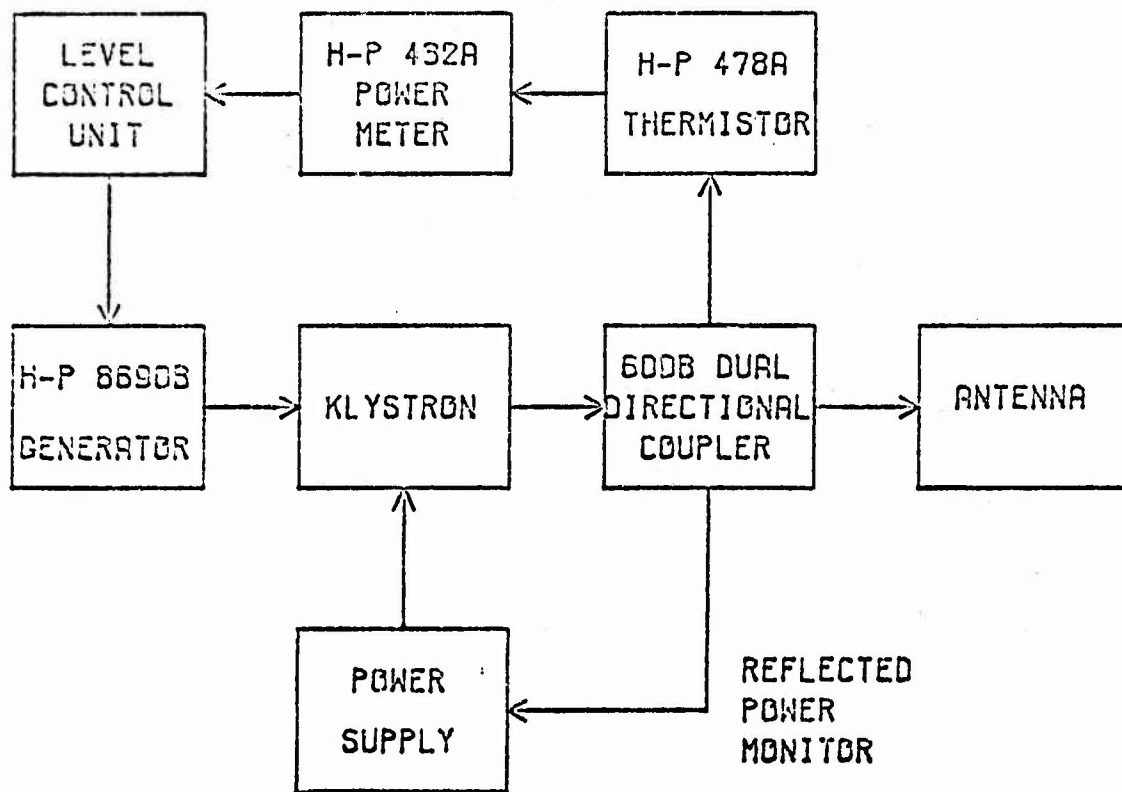

FIGURE 4

1/4 inch were drilled through the box to facilitate breathing, one through the center of the front plug and twelve through each side and top surface.

Individual exposures were conducted in the following manner: The rat was permitted to crawl into the styrofoam restraining box. The front and rear plugs were inserted and held in place with rubber bands. The box was then placed on a styrofoam platform with the rat's head directly facing the center of the dish antenna and aligned with the longitudinal axis of the antenna. In this exposure position, the focal point of the field fell approximately one-inch posterior to the interaural line. Each rat was exposed for the preselected duration and then immediately removed from the box. A lethal effect was defined as the absence of respiration five-minutes post exposure.

Results

With each exposure duration the percent mortality increased with increasing energy density levels. There were also systematic differences from the shortest duration of exposure to the longest duration. These relationships are depicted in Figure 5. The plotted points on the respective curves represent the percent mortality within the subgroups assigned to different energy densities. Numerical data corresponding to the plotted points and the number of subjects for each subgroup are also presented in Table 1.

It is evident from the family of curves depicted in Figure 5 that the lethal energy density (LD50) increases with increasing exposure durations, since the respective curves cross the 50-percent mortality level at progressively increasing points on the abscissa. In fact,

EXPOSURE DENSITY (rads - $\mu\text{R}/\text{cm}^2$)

	<u>1.12</u>	<u>1.24</u>	<u>1.36</u>	<u>1.48</u>	<u>1.50</u>	<u>1.60</u>	<u>1.72</u>	<u>1.84</u>
Age 1-14 Total (122)								
0-5	30(12)	34(13)	40(17)					
1-5	33(5)	45(22)	54(11)	100(9)				
2-5	11(12)	40(12)	46(13)	55(11)				
3-5				60(7)		36(14)	57(24)	100(12)

Table 1. Percent mortality and number (in parentheses) of runs per subgroup with four exposure area lots at 3000 Hz.

RELATIVE LETHALITY

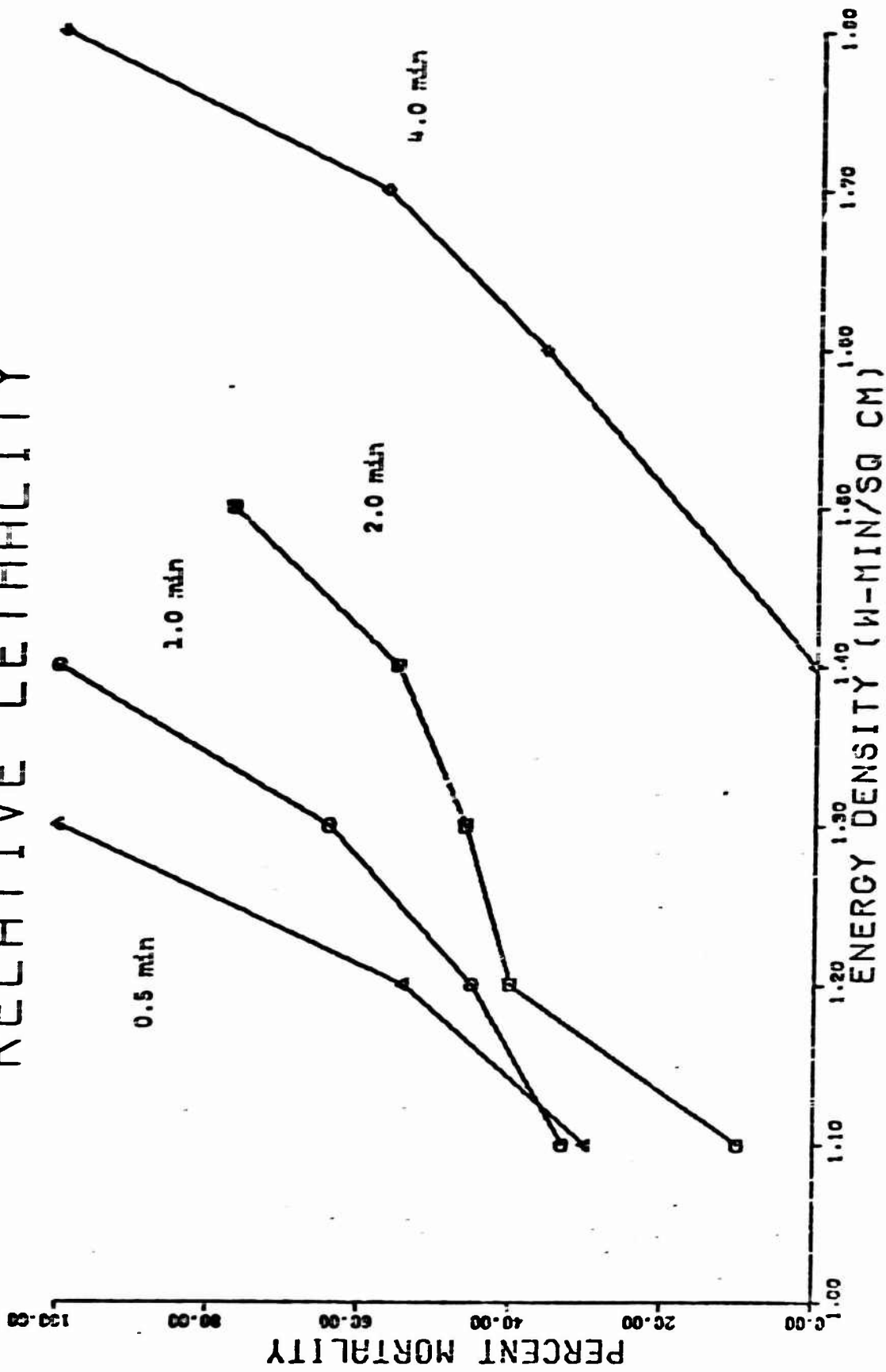

Figure 5. Relative lethality with four exposure durations at 3000 MHz.

the increase in LD50 values was close to a linear function of the exposure duration. Figure 6 illustrates this relationship more clearly than Figure 5. The plotted points in Figure 6 represent the LD50 estimates determined by linear extrapolation using the data from the two subgroups at each duration which fell the closest to the 50-percent mortality level.

Discussion

The increase in energy required to produce a lethal effect at 4.0 minutes as compared to 0.5 minutes was substantial, amounting to approximately 40 percent. Until determined otherwise, these differences should probably be attributed to heat loss from the subjects by active heat transport, by simple conduction, or both. It seems reasonable to expect that the longer the duration of exposure, the more heat will be eliminated, serving to protect the subject to some degree.

The present data with rats are similar to the mouse data reported by Susskind (1961). A comparison of the two studies is facilitated by converting the present lethal energy estimates to lethal power estimates. This is done by dividing the respective lethal energy values by the duration of exposure employed. The lethal power densities were a decreasing monotonic function of the exposure duration. This relation is depicted in Figure 7. The general shape of this curve resembles the curve reported by Susskind, although the power levels employed in the two studies differed markedly.

Although there are some similarities between the present study and Susskind's study, the data from the two studies are far from identical. Our lowest lethal power (417 mw/cm^2), which was found with a four-minute

LETHAL ENERGY DENSITY

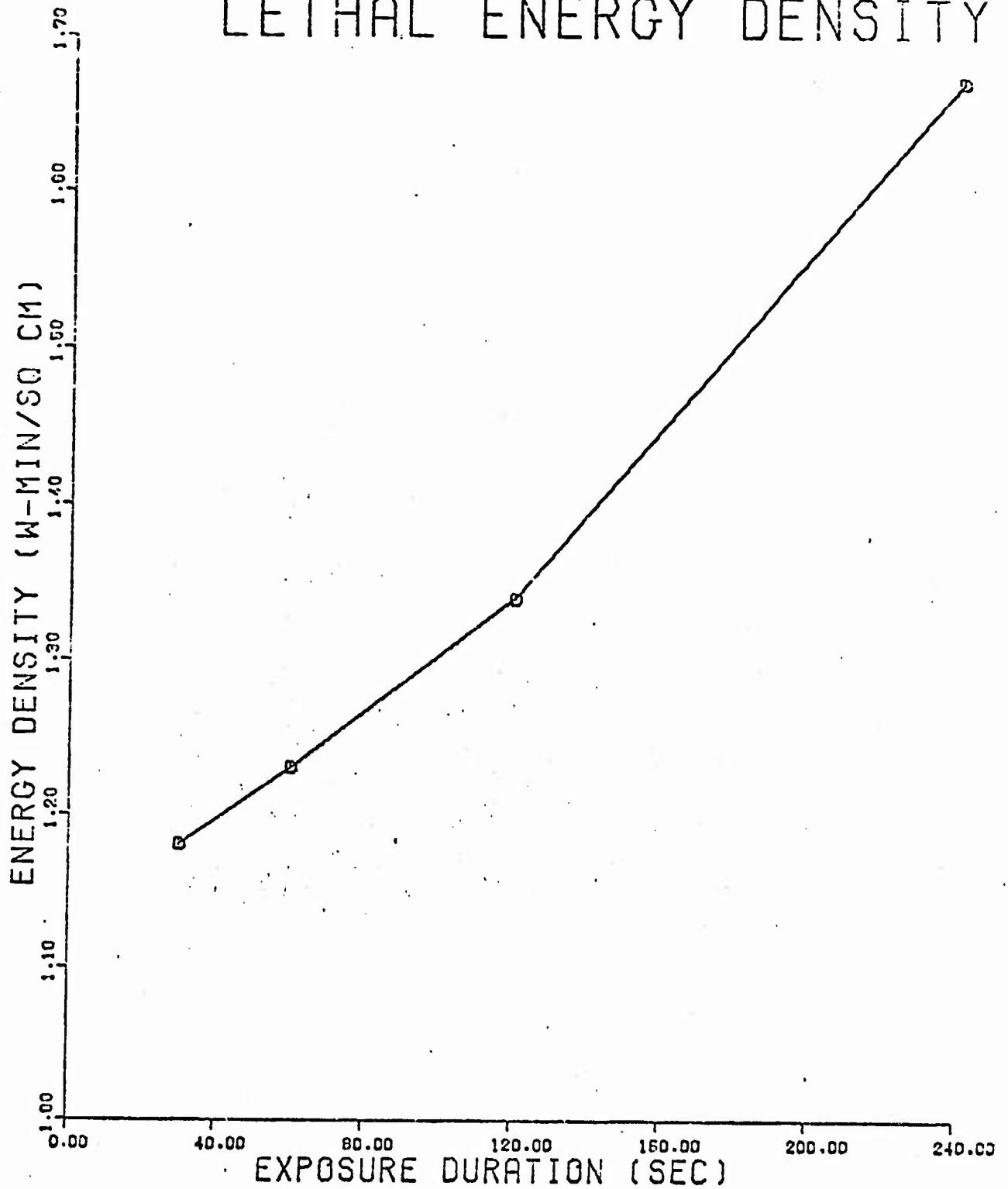

Figure 6. Estimated lethal energy density as a function of exposure duration at 3000 MHz.

LETHAL POWER DENSITY

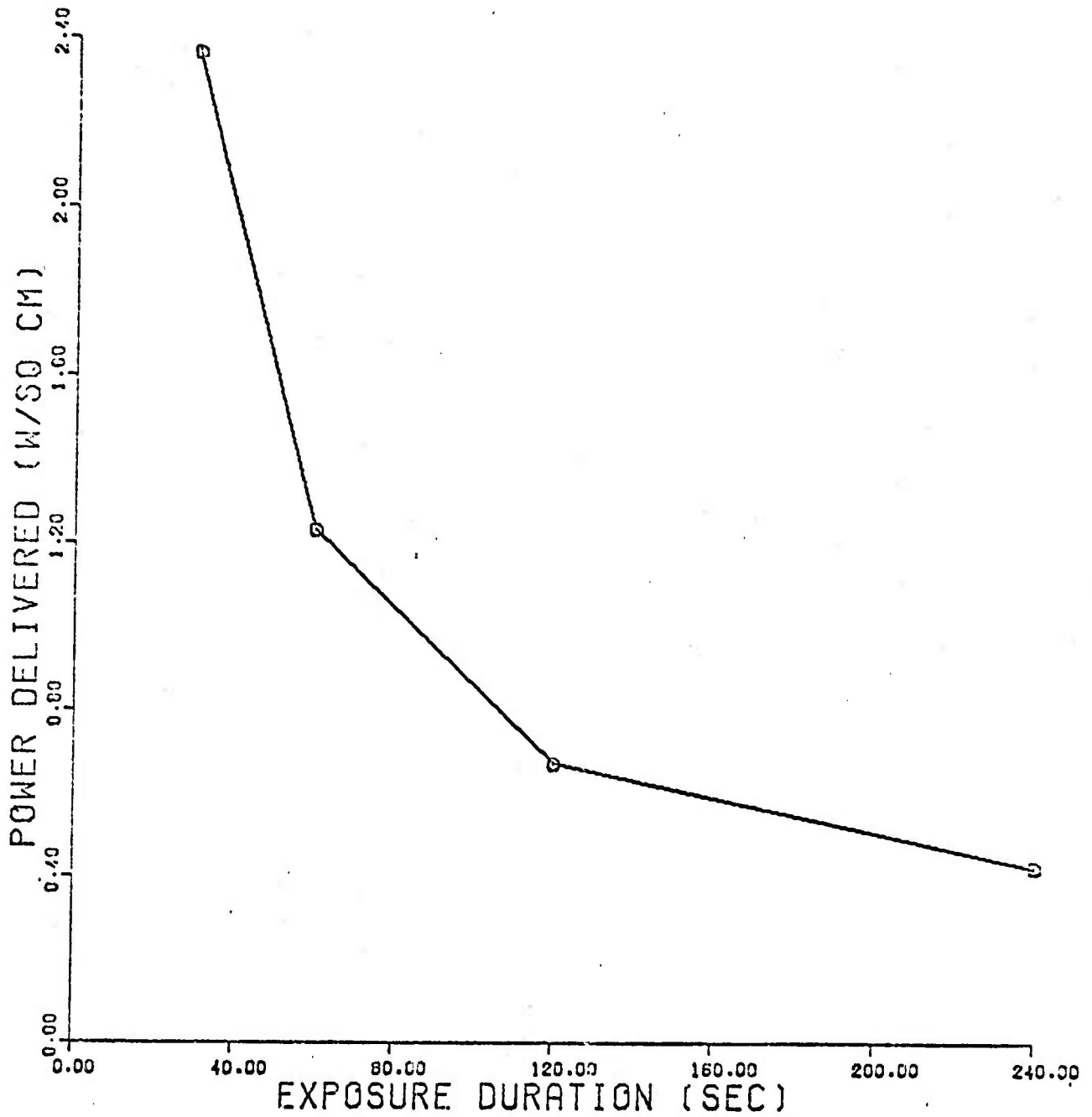

Figure 7. Estimated power densities required to produce a lethal effect (LD50) with four different exposure durations at 3000 MHz.

exposure durations, is within 10 percent of the highest power level which Suskind used (380 mw/cm^2). With 380 mw/cm^2 Suskind found an approximate lethal duration of only 2.2 minutes, considerably less than the 4.0 minutes necessary in our study. At this time, there is no firm explanation for this difference, other than citing some of the obvious procedure differences, e.g., species, body size of the subjects, microwave variables, exposure apparatus, etc. A considerable parametric effort will be required to examine the general relevance of each of the above differences.

II. BEHAVIORAL EFFECTS

Introduction

The absence of systematic evaluation of the lethal effects of microwave irradiation stands as no exception in the biological effects literature. There have also been few studies which have carefully examined behavioral performance measures and an even fewer number in which standard free-operant techniques have been employed. Justesen and King (1969) have, however, reported that performance reinforced with sucrose solutions shows progressive decrements as power levels are increased in a closed-space, multi-mode, exposure apparatus.

The present study employs more conventional procedures. This portion of the study examined the effects of microwave exposure on performance maintained by food pellets. Both power density level and wave length were systematically evaluated to determine the relative effects of each variable during exposures in a "free-space" situation.

Method

The subjects were three male and three female Wistar rats obtained from the Walter Reed colony. All animals were approximately one-year old at the outset of this study. Prior to training, the rat's weights were reduced by food restriction to an experimental weight approximately seventy percent of free-feeding weight. Experimental weight for males was 300 grams, for females, 200 grams. The rats were individually housed in a temperature controlled chamber, maintained at $76 \pm 2^\circ$, under constant illumination. Prior to the formal experiment, the males had experienced 40-training sessions, but had never been exposed to

microwaves. The three females had been trained for 120 sessions and had received numerous exposures.

The training box was made of 1/4" clear plexiglass and measured 12" long, 12" high, and 10" wide. A plexiglass feeder cup was mounted in the center of the 12" x 10" front wall, 3/8" from the floor. A plastic tube (Tygon, 5/8" diameter) connected the feeder to the pellet dispenser. The response bar was positioned to the right of the feeder cup and was made of 1/2" plexiglass. This bar was mounted to a retracting device by two small metal pins which extended into the box. A 1-1/8" thick piece of absorber (Eccosorb, Type AN, Emerson and Cuming) separated the bar retractor from the wall through which the bar moved.

At approximately the same time each day, seven days per week, each rat received a 15-minute training session on an FR 10 schedule. With this schedule every ten presses on the response bar automatically produced one food pellet. Solid state circuitry controlled the contingencies and recorded response output.

When an exposure session was scheduled, irradiation began with the onset of the third one-minute interval of the session and was automatically terminated with the offset of the first one-minute interval during which fewer than ten responses had occurred. If the rat responded throughout the session, irradiation ceased at the end of the 15-minute session, resulting in a maximum exposure duration of 13-minutes. The response bar was retracted at the end of the session or when the irradiation ceased. The primary measure of performance was the time to work stoppage which was defined as the time elapsed from the onset of irradiation to the point where the rat received the last food pellet.

During an exposure series the training box was placed on a styro-foam pedestal, in front of the antenna, in an anechoic chamber maintained at $70 \pm 1^\circ\text{F}$. Relative to the antenna, the bar and feeder cup were on the right wall of the box. The bar retractor and pellet dispenser were located to the right of this wall and were shielded with ceramic absorber (Eccosorb, Type H-T, Emerson and Cuming).

The transmitting antennas employed were Scientific-Atlanta Series 12 standard gain horns. The antennas were calibrated using the identical horn technique. A sleeve dipole transfer standard was then calibrated against the measured gain of the Scientific-Atlanta horn and this third antenna was used to establish the axial power density in the experimental situation. At 2450 MHz a NARDA Model 8100 dosimeter was used as a further check on the exposure level. This device was also standardized against the Scientific-Atlanta horns as mentioned above. The transmitter employed was as described earlier. A family of klystron amplifiers was employed appropriate to the frequency of interest.

The axial distance from the center of the antenna horizontally to the point at which calibrations were made was approximately four feet. The training box was positioned so that this calibration point was located three inches above the floor of the box and two inches into the box from the side nearest the antenna. As a rat pressed the response bar, it was typically oriented lateral to the antenna with the calibration point falling in the center of the rat at shoulder level. Polarization was vertical.

The microwave exposure parameters were as follows: Both frequency and power were varied systematically. At a particular frequency,

each rat received a set of six successive microwave sessions, one per day, at each of five power levels (25, 50, 75, 100, 150 mw/cm^2). Each rat received 100 mw/cm^2 on the first and last sessions within the set. The sequence for the remaining four power levels was mixed and differed for each rat.

Sets of observations at each power level were made at four different frequencies. In sequence, the frequencies used were 1700, 3000, 2450, 750, and 1700 MHz. The 1700 MHz observations were repeated at all power levels to assess the possibility that the extreme effects observed were due to that frequency being tested first. Typically, at least seven daily training sessions elapsed between sets of power observations. This was required to allow sufficient time for transmitter tube and antenna changes and recalibrations.

Results

Frequency and power density level both proved to be of major importance in determining performance alterations obtained during exposure. At each frequency, higher power levels resulted in shorter times to stoppage. The effect of frequency was more complex in that a non-monotonic function resulted. At all power levels which resulted in a complete cessation of performance, 1700 MHz produced the shortest stoppage times. Both higher and lower frequencies had progressively less influence. These frequency and power effects are illustrated in Figure 8. The plotted points represent the mean scores for the data of all six subjects combined. Scores for the males and females were combined since no major differences were found between them.

FREQUENCY X POWER SERIES

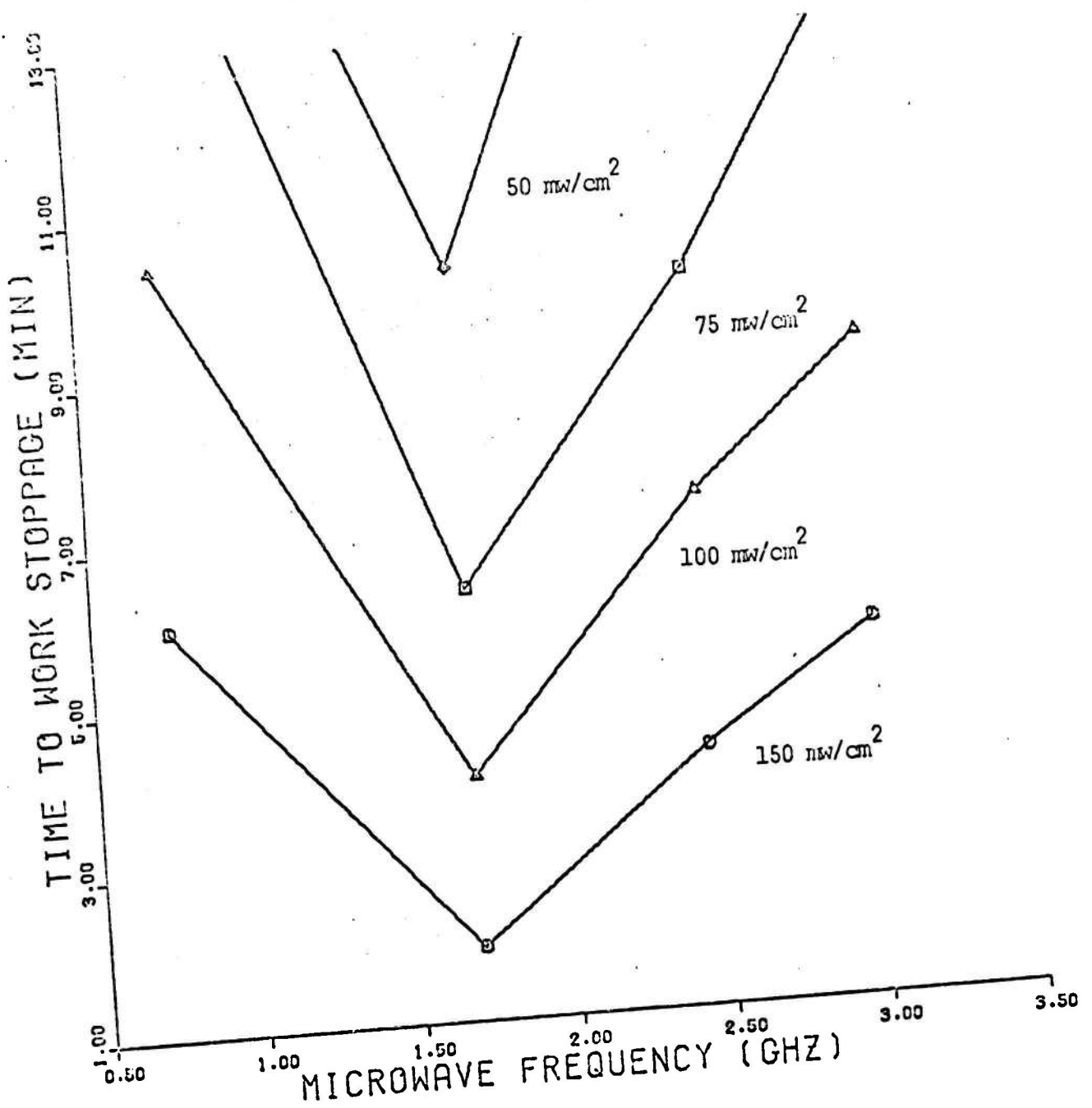

Figure 8. Time to work stoppage as a function of microwave frequency and power density. Plotted points are mean scores for all six rats. Scores of 13 min which indicated no stoppage within the maximum exposure time permitted were excluded from the graph.

The U-shaped curves in Figure 8 which represent the mean scores for the subjects as a group are quite representative of what appears to be a general frequency phenomenon, since the respective scores for each of the individual rats exhibited very similar trends. Data for each of the individual subjects are presented in Figures 9a through 9f.

The effects of power density appeared quite typical, with lower powers resulting in longer times to response termination. However, this relationship was by no means linear. Figure 10 shows these power effects somewhat more clearly than Figure 8. Substantial curvature is revealed in two of the plots, particularly for the 1700 MHz function. Since only two points were obtained for the other frequencies, the shape of the curve is indeterminate. More than likely curvilinear trends would have been revealed at the other frequencies as well had a longer session length been employed.

Energy density levels which were required to produce a termination of responding (effective energy density) were a decreasing function of the power density levels. This relation appeared to hold for each frequency although fewer representative data points were obtained for the least effective frequencies because of the fixed time limit for the exposures. Figure 11 illustrates the effective energy densities for different power levels and different signal frequencies. The most extreme differences between two power levels is that between 50 and 150 mw/cm^2 at 1700 MHz. As compared to the effective energy density at 150 mw/cm^2 an increase in energy of approximately 80 percent was required to produce response termination with 50 mw/cm^2 .

RAT 470

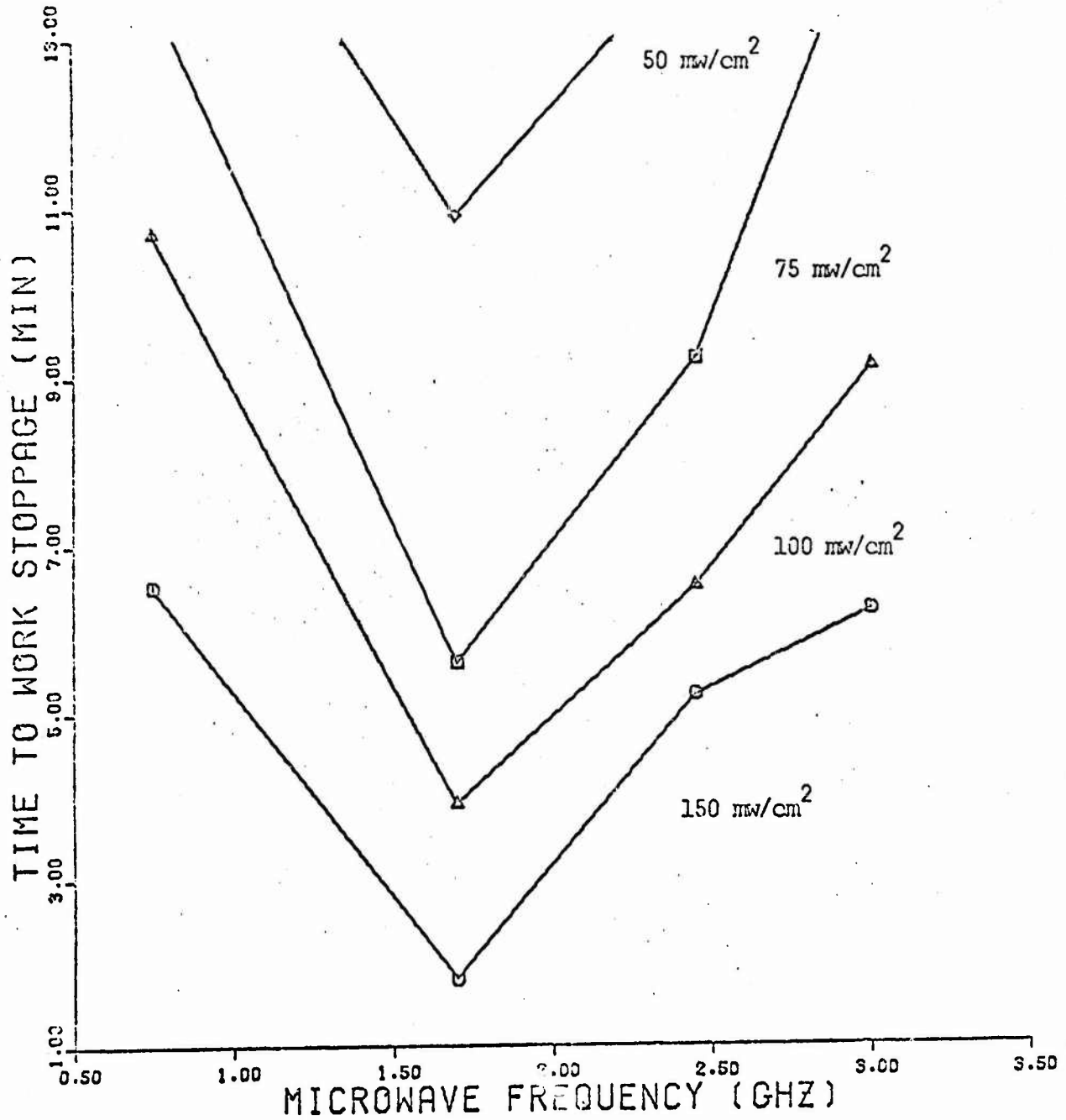

Figure 9a. Performance scores for RAT 470 (female).

RAT 472

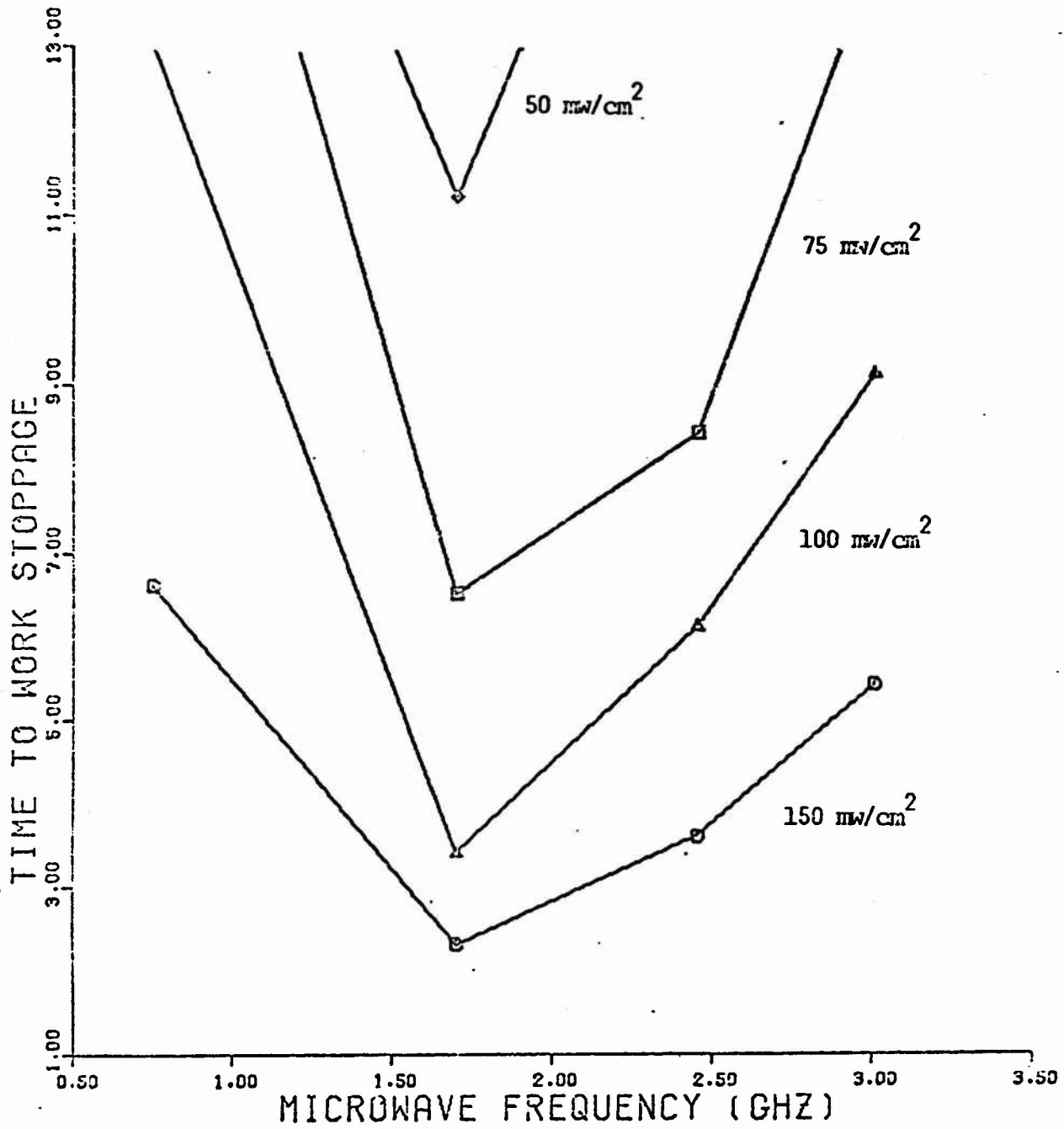

Figure 9b. Performance scores for RAT 472 (female).

RAT 473

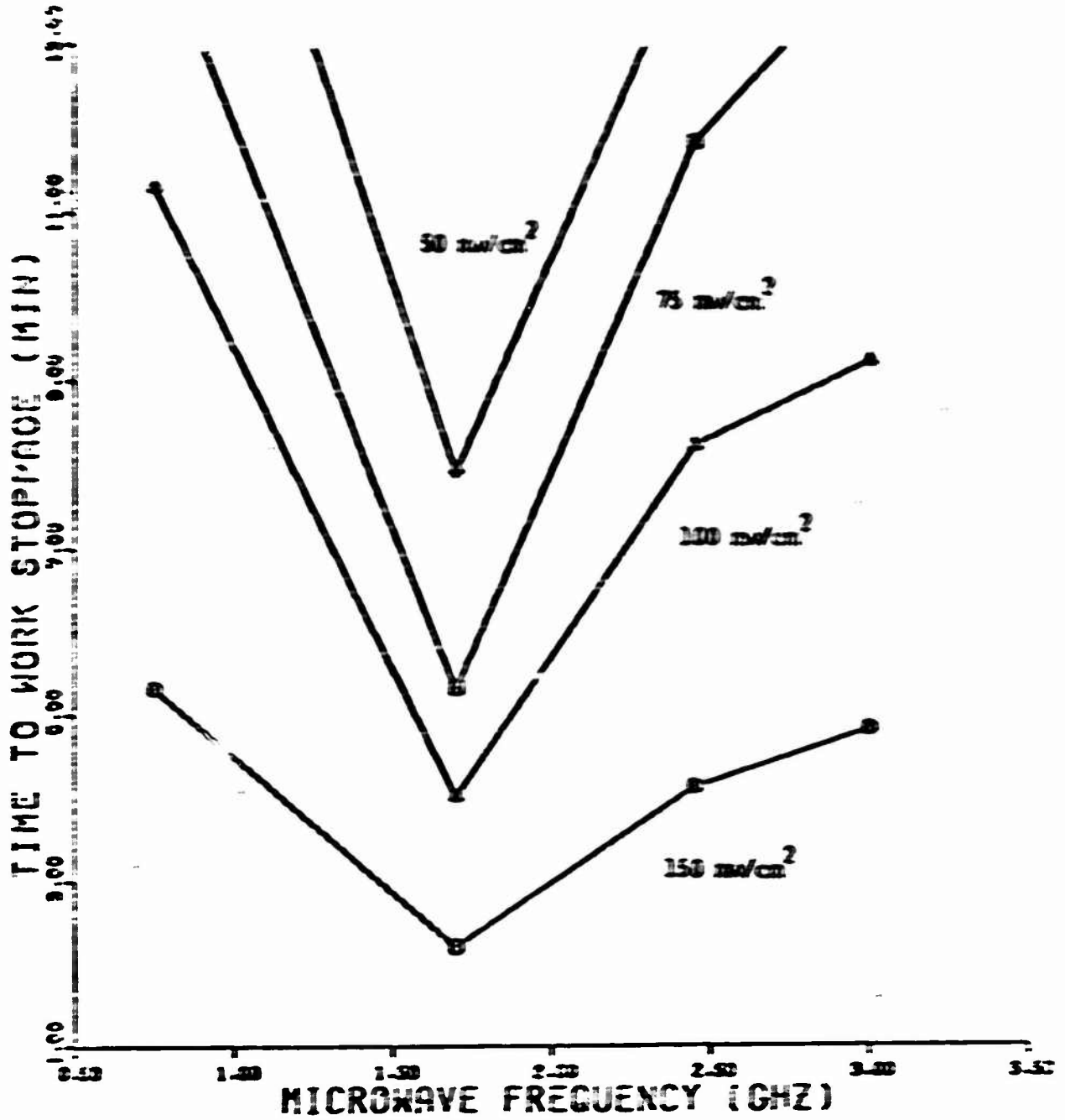

Figure 9c. Performance scores for RAT 473 (female).

RAT 491

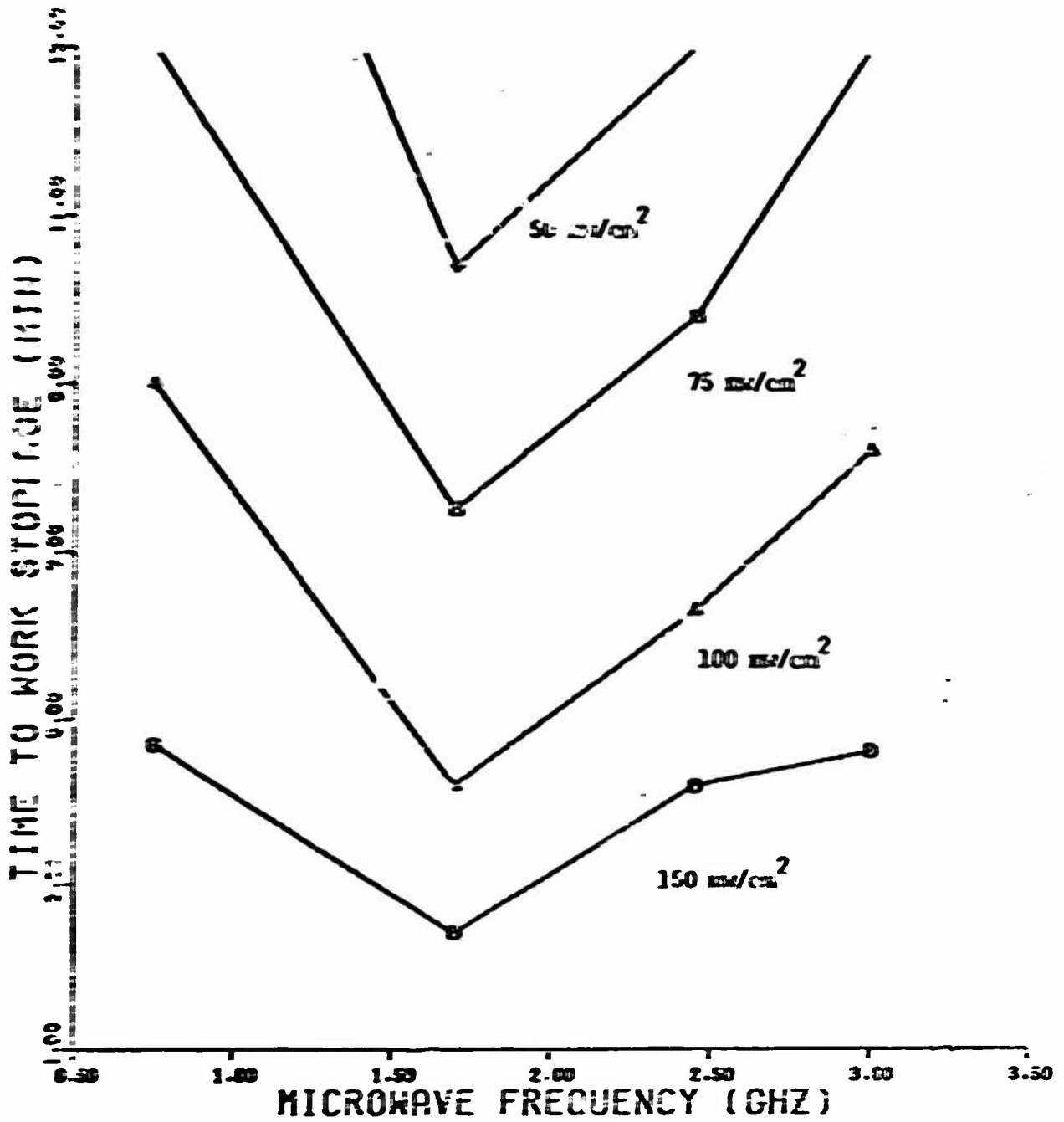

Figure 9c. Performance scores for RAT 491 (male).

RAT 493

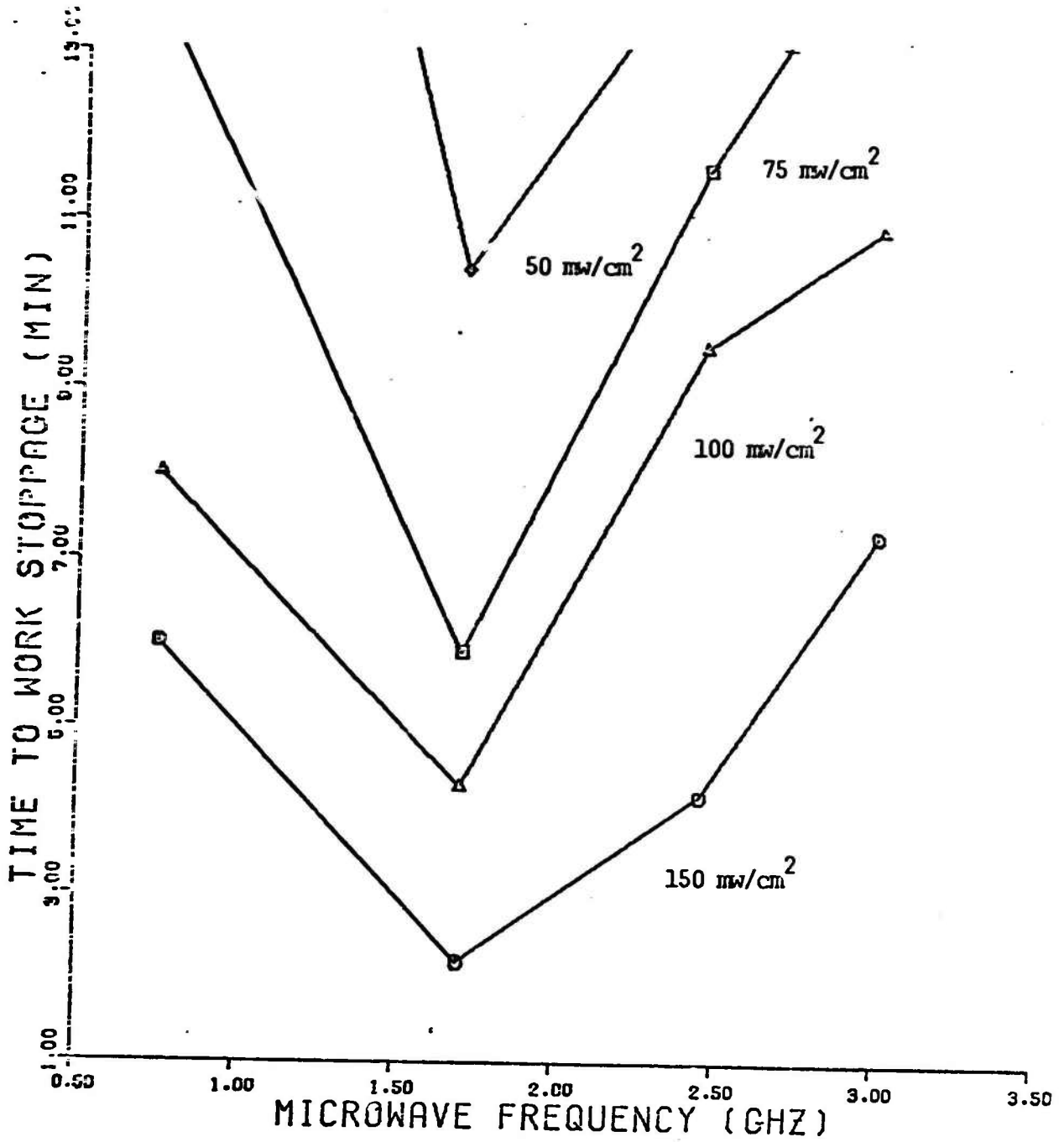

Figure 9a. Performance scores for RAT 493 (male).

RAT 494

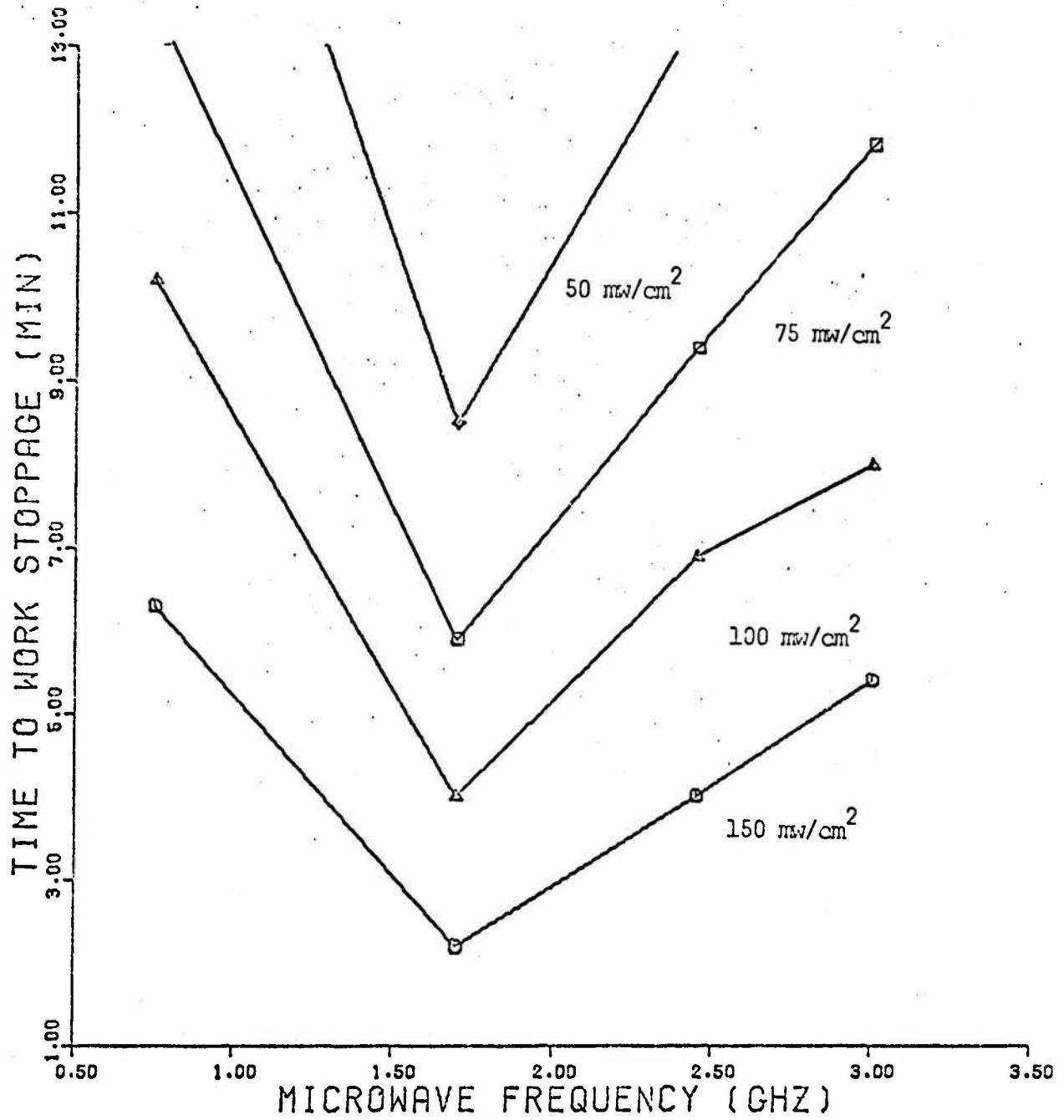

Figure 9f. Performance scores for RAT 494 (male).

FREQUENCY X POWER SERIES

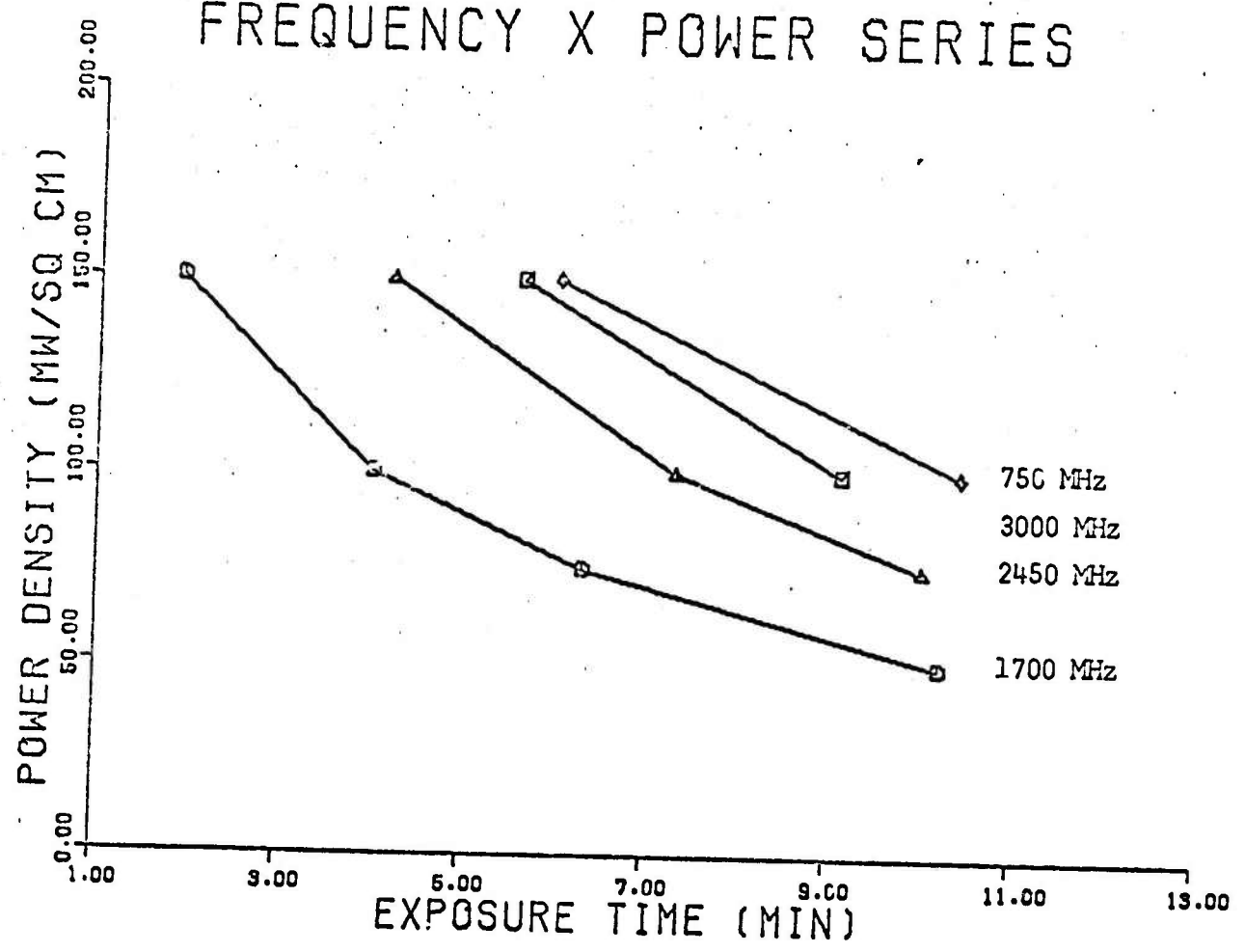

Figure 10. The relationship between power density and exposure time to work cessation at four microwave frequencies. Note, the power levels were fixed and exposure time was determined by the subject. Data at power levels where no stoppage occurred have been excluded.

EFFECTIVE ENERGY DENSITY

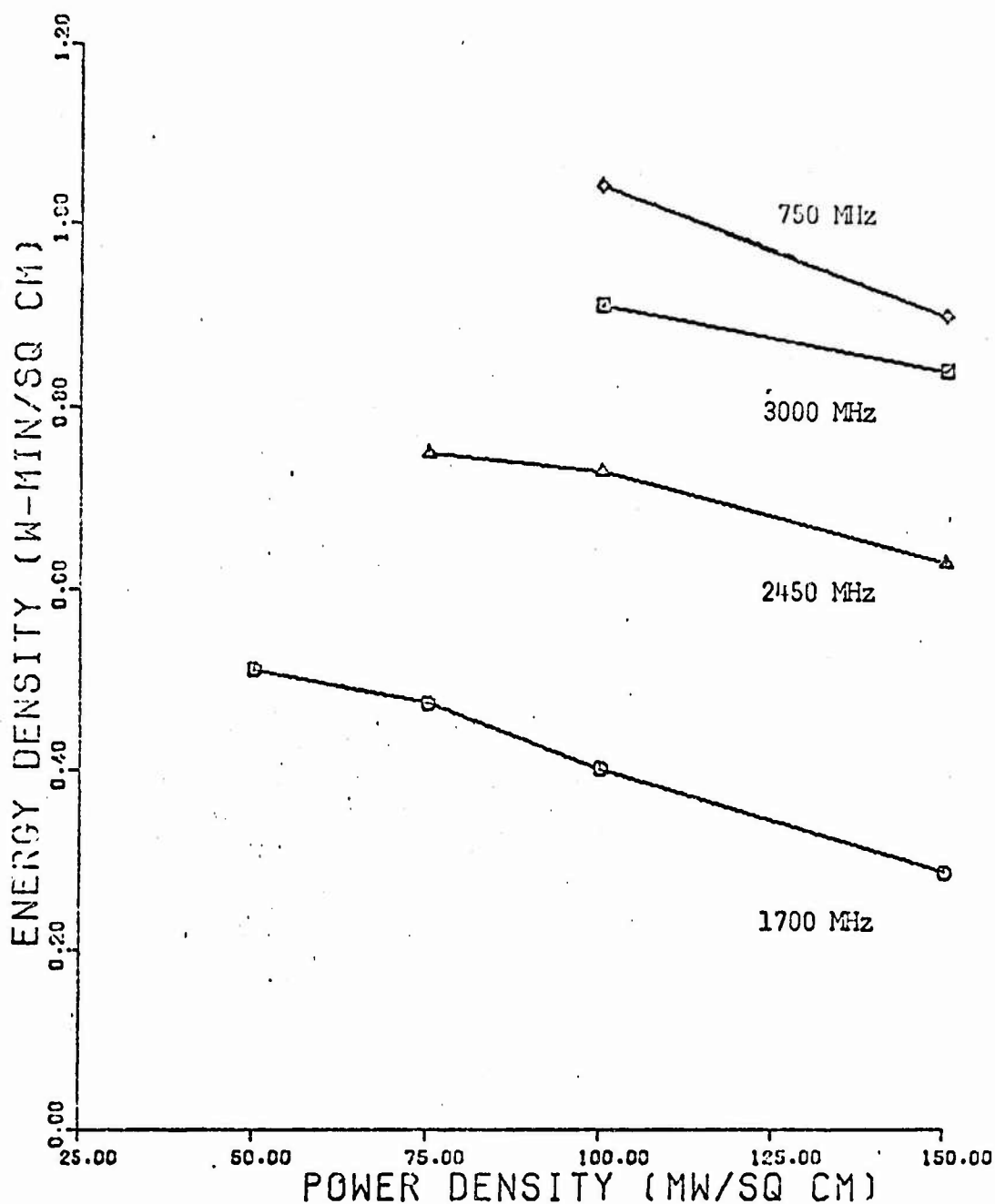

Figure 11. Effective energy density levels as a function of power density at four microwave frequencies. Effective energy density was defined as the energy density (power x time) required to produce a termination of performance.

Discussion

The present behavioral study provides substantial evidence that rats are selectively sensitive to intermediate microwave frequencies within the range of 750 to 3000 MHz. This result was quite unexpected, with the exception of our own pilot work which suggested such an effect. While the present study was in progress an interesting report was published which may be valuable in interpreting the present results (Kritikos and Schwan, 1972).

Using mathematical modelling techniques, Kritikos and Schwan predicted the distribution of the heating potential generated by an incident electromagnetic plane wave on different size spheres having electrical characteristics similar to those of biologic tissues. Their model suggests that intense hot spots occur inside spheres with a radius of 5 cm. Maximal heating potentials are predicted for a frequency of 900 MHz, with lesser effects predicted for both higher and lower frequencies.

If one assumes that the frequency effects observed in the present study were due to differential generation of "hot spots" which in turn inhibited the performance, a general predictive value can be attributed to the model presented by Kritikos and Schwan. The extent to which such assumptions are warranted, however, needs careful examination. Where are the predicted hot spots located? Do they occur in the rat trunk, in the brain, or in both? If such hot spots occur at all in rats, how do they combine with surface heating to produce biological effects, in particular, behavioral effects? What would be the distribution of these hot spots in moving animals? The answers to these questions must

be obtained in order to evaluate whether or not the correspondence between the present behavioral data and a model of heating potential is anything other than a mere coincidence.

The close similarity in performance effects which obtained from one rat to the next is interesting, especially since the males and females were quite different in body weight. This suggests that body mass, within ranges employed here, may not be a particularly influential variable when dealing with microwave effects. Michaelson (1961) has reported similar observations with dogs. However, it should be noted in passing, that such a conclusion runs counter to theoretical work by Hoeft (1965).

An additional interesting feature of the data concerns the relatively severe effects of fairly low powers. At the 1700 MHz frequency, a power of only 50 mw/cm^2 produced a complete cessation of bar-press responding within a ten-minute exposure period. A level of 50 mw/cm^2 , of course, is relatively close to the safety level of 10 mw/cm^2 established for humans exposed to microwave fields. The fact that microwave effects are found at power levels not far above the established safety level points to the necessity for additional, careful, and comprehensive examinations of the biological effects of microwaves, with a variety of species.

It is possible that not only the rat, but other species as well, may exhibit enhanced sensitivity to certain microwave frequencies. It is equally possible that a frequency dependency is not idiosyncratic of behavioral performance but obtains with a variety biological measures

such as lethality and thermal changes in the gut, brain, eyes and testicles. All of these possibilities will of course not be realized, but to the extent that at least some are, we will have come closer toward the goal of gaining an understanding of the biological effects of microwaves.

REFERENCES

hoeft, L.O. Microwave Heating: A Study of the Critical Variables for Man and Experimental Animals. Aerospace Medicine, 1965, 38, 621-622.

Justesen, D.R. and King, N.W. Behavioral Effects of Low-Level Microwave Irradiation in the Closed-Space Situation. Symposium Proceedings, 1969. Bureau of Radiological Health, (BRH-IDBE 70-2), 154-179.

Kvitikos, H.N. and Schwan, H.P. Hot Spots Generated in Conducting Spheres by Electromagnetic Waves and Biological Implications. IEEE Transactions on Biomedical Engineering, 1972, BME-19, 53-58.

Michaelson, S.M. Biological Effects of Microwave Exposure. Symposium Proceedings, 1969, Bureau of Radiological Health, (BRH/DBE 70-2), 35-58.

Susskind, C. Longevity Study of the Effects of 3-CM Microwave Radiation on Mice. Institute of Engineering Research, 1961, Series 60, Issue 382, (AD 269 385).